



INTERNATIONAL EDITION

# PRODUCT CATALOG 2022/2023





<b>Aluminum Bottle</b>	<b>1</b>
Overview	1
Specification	4
Customized Model Types	6
Available Lids	7



<b>Aluminum Aerosol Can</b>	<b>8</b>
Overview	8
Available Shapes	10
Specification	11
Available Caps	13



<b>Aluminum Anti-theft Bottle</b>	<b>15</b>
Overview	15
Available Volume	17
Specification	18

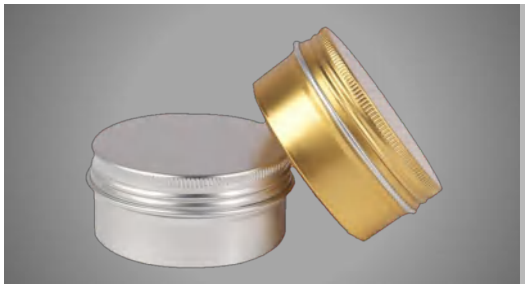

<b>Aluminum Jar</b>	<b>19</b>
Overview	19
Capacity	22
Specification	25



<b>Aluminum Collapsible Tube</b>	<b>27</b>
Overview	27
Nozzle	30
Specification	31



When you are looking for "aluminum packaging", aluminumrock as a leading manufacturers since 2017 is definitely your top choice.

### More than just a bottle: a sense of trust

Every client is different, every bottle is individualized – Aluminumrock reflects this individuality in its aluminum products.

Whether you choose a Aluminum Bottle, Aluminum Aerosol Can, Industry Aluminum Bottle, Aluminum Collapsible Tube, or Aluminum Jar, we offer a **wide range of options**, fashion, reliability and safety.

With Aluminumrock, you can cover a wide range of packaging options.

- Aluminum bottles for maximum freedom of choice
- Aluminum aerosol can for maximum freedom of fashion, skincare, cosmetic choice
- Industry aluminum bottle - to cover a wide range of industrial use
- Aluminum collapsible tube - ideal for pharmaceutical, skincare, cosmetic use
- Aluminum jar for a wide range of options



- SGS, FDA, SEDEX Audit Approve
- More than 1 billion aluminum packaging sold worldwide



**PRODUCTION WORK FLOW**

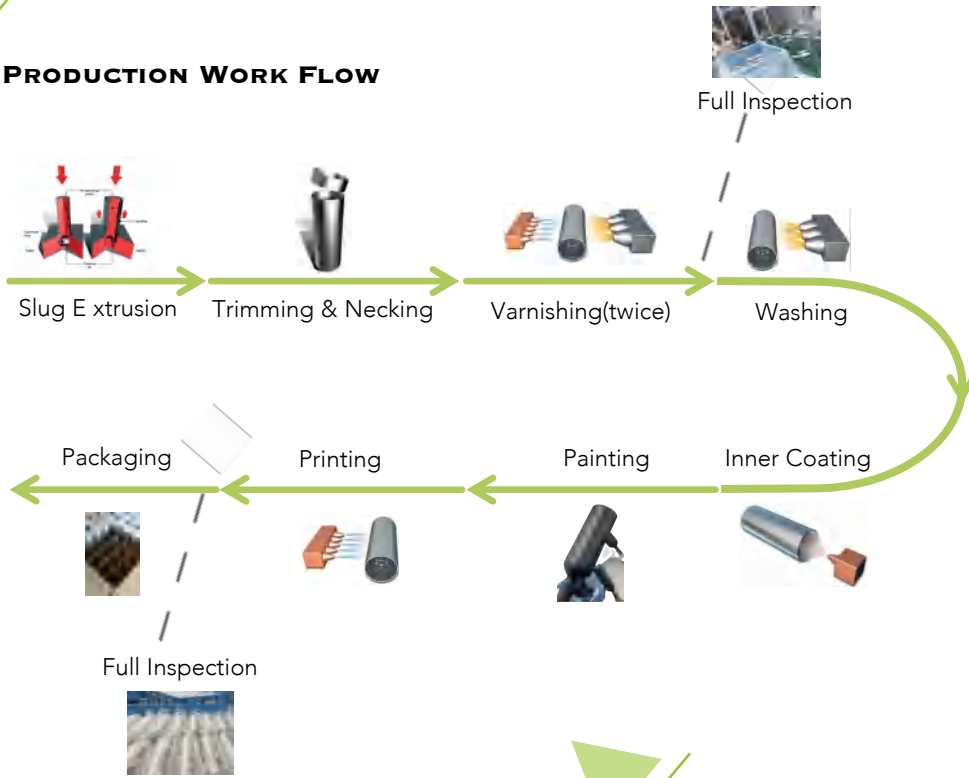

**PRINTING SOLUTIONS**





## PRODUCTION WORK FLOW VIDEO

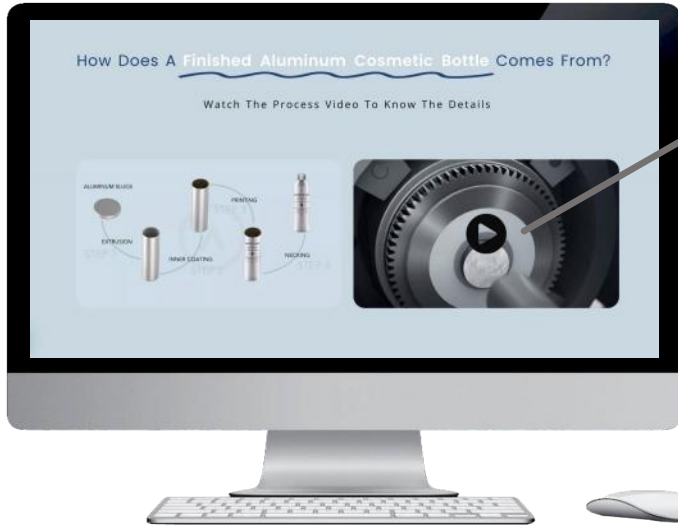

[Click to Watch Production Video](#)

**TIPS**  
THE VIDEO SIMPLY SHOW THE WORK FLOW OF ALUMINUM BOTTLE PRODUCTION

ALUMINUM BOTTLE



## HAPPY CLIENTS TESTIMONIALS VIDEO

**Tips**

- Excellent
- Good communication
- Good service

These testimonials are all from our current clients overseas

[Click to Watch Testimonials Video](#)



DIAMETER	HEIGHT	CAPACITY		CARTON SIZE L X W X H	PIECES PER CARTON	NET WEIGHT	GROSS WEIGHT
		FILLING VOLUME					
MM	MM	ML	OZ	CM	PCS/CTN	KGS/CTN	KGS/CTN
ø 25	60	15	0.5	50 x25 x32	1000	6.2	7.2
	75	20	0.7			7.2	8.2
	95	30	1	50 x25 x39	800	7.6	8.6
ø 32	76	30	1	43 x43 x32	400	3.9	4.9
ø 35	85	50	1.7	43 x43 x46	500	6.5	7.3
	95	65	2.2	43 x43 x42	400	5.6	6.6
	106	80	2.7	43 x43 x46		6	7
ø 36	83	50	1.7	43 x43 x46	500	6.5	7.5
	94	65	2.2	43 x43 x42	400	5.8	6.8
	106	80	2.7	43 x43 x46		6.2	7.2
ø 40	110	100	3.4	43 x43 x46	400	7.6	8.6
	135	120	4	43 x43 x42	300	6.3	7.3
ø 45	115	120	4	48 x48 x36	300	6.9	7.9
	143	150	5	48 x48 x45		7.2	8.2
ø 48	150	200	6.8	52 x52 x32		5.8	6.8
	176	250	8.5	52 x52 x38	200	7.1	8.1
	195	300	10	52 x52 x41		7.6	8.6
ø 50	150	200	6.8	52 x52 x32	200	6	7
	174	250	8.5	52 x52 x38		7.2	8.2
	192	300	10	52 x52 x41		7.8	8.8
ø 59	160	350	12	62 x37 x33	126	5.3	6.3
ø 65	190	500	17	59 x41 x39	120	6.1	7.1
	205	600	20	59 x41 x42		7.4	8.4
ø 74	104	300	10	62 x47 x17	48	3.3	4.3
	135	400	13.5	56 x48 x42	126	6.1	7.1
	226	750	25	56 x48 x46	48	6.6	7.6
ø 80	161	500	17	67 x51 x19	48	3.5	4.5
	238	1000	34	52 x52 x49	30	6.2	7.2



For the round shoulders regular bottle, **15ml to 1L** volume is available



**KEY MESSAGES YOU NEED TO KNOW**

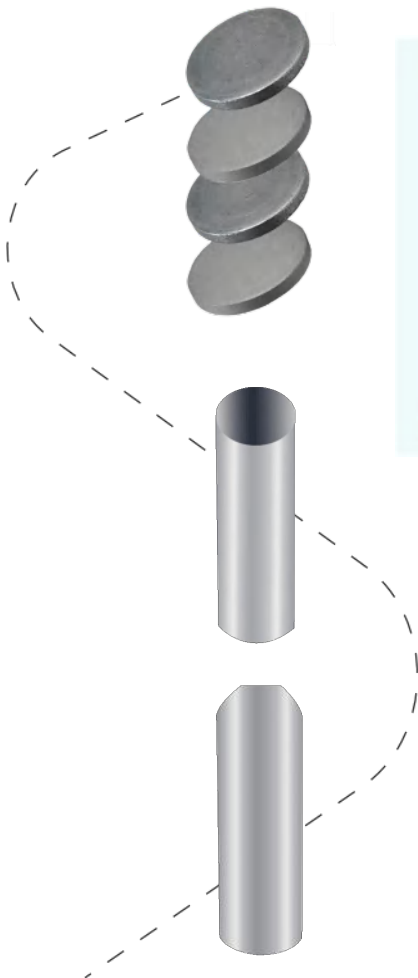

The size of the aluminum slug determines the diameter of the bottle,  
 and one diameter of the slug can be stretched to different heights, in this stretching process,  
 while the general factory will adjust the whole straight shape into **round shoulders**.

so the regular round -shouldered bottles are all of the above shapes, with only the difference in capacity.  
***If you need shaped bottles such as the overall square shape, the shoulder is flat, square, or anything that is not round can be customized.***



**THE CUSTOMIZED MODLE TYPES**

**POWDER BOTTLE**



**CAPSULE BOTTLE**



**LONG NECK BOTTLE**



**SHAMPOO FAT BOTTLE**



**EFFERVESCENT TABLET BOTTLE**



**FLOWER SHAPE BOTTLE**



**INSIDE SCREW BOTTLE**



**POWDER LIFTER BOTTLE**



**CIGAR BOTTLE**



**STICK BOTTOM TWIST UP BOTTLE**



**OTHER CASES OF CUSTOMIZED SHAPED BOTTLE**



ALUMINUM BOTTLE



**Click**

To Get [Quotation](#) For Your Customized Bottle







**A VARIETY OF LIDS ARE AVAILALE**



Stainless Steel Pump



Mist Sprayer



Trigger Sprayer



Lotion Pump



Mini Trigger Sprayer



Glass Drop



Leaf Shape Lotion Pump



Scream Pump



Wood Screw Cap



Threaded Aluminum Cap



Screw Aluminum Cap



Wooden Lotion Pump

ALUMINUM BOTTLE



When you are looking for “aluminum packaging”, aluminumrock as a leading manufacturers since 2017 is definitely your top choice.

### More than just a aerosol can: a sense of trust

Aluminumrock is able to meet all your requirements concerning diameters, lengths, shoulders and pressure resistance **over 18 bars**.

Easy to store, aerosol can allows safe management throughout the entire supply chain and it is the ideal packaging for a large number of products:

- ✓ Cosmetics, body and hair care
- ✓ Food industry, with products such as fresh cream and cream toppings Dyes, insecticides and
- ✓ chemicals
- ✓ Home and car care
- ✓ Medical devices and over-the-counter drugs

Aluminumrock offers a large choice of finishes:

**from transparent metallic overvarnish to more sophisticated effects (mat, gloss, pearl, glitter, glazed, metallic).**

★★★★★

ISO 9001 Quality Management Standard  
SGS, FDA approve



## AUTOMATIC PRODUCTION WORK FLOW

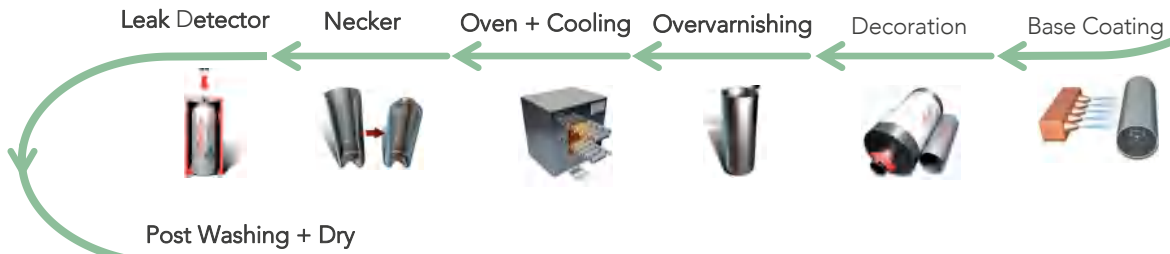
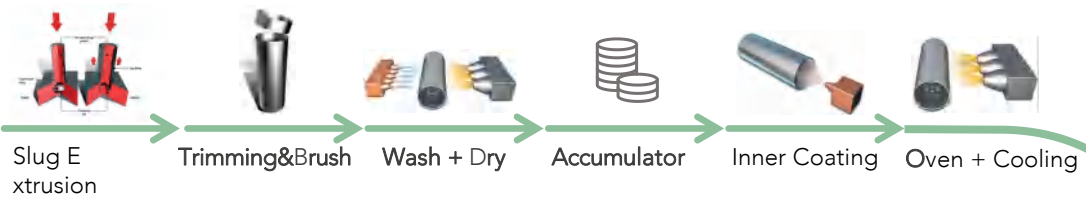

## PRINTING



8 Colors Available

Special finishes and unlimited design possibilities.



Options

- ✓ Glitter effect
- ✓ Pearlescent effect
- ✓ Brushed aluminum effect
- ✓ Multicolor coatings



## AVAILABLE SHAPES

### SHAPERS

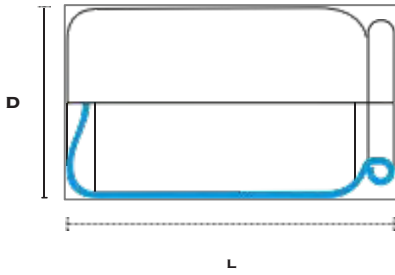

### VERSIONS



1 INCH  
OVAL



1 INCH  
SHAPED



1 INCH  
RIM SHOULDER  
*Available on  
round, ogival, fat*

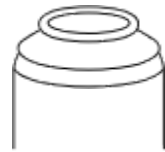

1 INCH  
TRANSFER SHOULDER

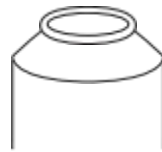

1 INCH  
FLAT SHOULDER



1 INCH  
GORGE



20MM  
CRIMP FLAT SHOULDER



DIAMETER	DIMENSION D x L	LIQUID GAS	COMPRESSED GAS	BRIMFUL CAPACITY	FILLING VOLUME							SHOULDER SHAPE + OPENING							COLOURS
					ML	ML	ML	1" Oval	20mm Crimp Oval	1" Transfer Shoulder	1" Gorge	1" Rim Shoulder available on round, oval, flat	1" Flat Shoulder	1" Shaped					
Ø22	22 x 56	12	-	17	✓												6		
	22 x 58	13	-	18	✓												6		
	22 x 60	14	-	19	✓												6		
	22 x 68	15	-	22	✓												6		
	22 x 75	17	-	24	✓												6		
	22 x 85	20	-	28	✓												6		
	22 x 100	23	-	33	✓												6		
	22 x 150	35	-	50	✓												6		
Ø25	25 x 65	19	-	27	✓						✓						6		
	25 x 68	20	-	8	✓						✓						6		
	25 x 95	30	-	41	✓						✓						6		
Ø31.5	31.5 x 78	-	-	53	✓												6		
	31.5 x 165	-	-	113	✓												6		
Ø35	35 x 65	35	-	54	✓										✓		6		
	35 x 70	40	33	59	✓										✓		6		
	35 x 88	50	42	75	✓										✓		8		
	35 x 97	50	42	75	✓										✓		8		
	35 x 105	-	50	89	✓										✓		8		
	35 x 125	75	-	110	✓										✓		8		
	35 x 135	80	65	118	✓										✓		8		
	35 x 156	100	75	140	✓										✓		8		
Ø45	45 x 105	100	75	140	✓				✓	✓	✓	✓	✓	✓	✓		8		
	45 x 125	125	100	175	✓				✓	✓	✓	✓	✓	✓	✓		8		
	45 x 150	150	125	210	✓				✓	✓	✓	✓	✓	✓	✓		8		
	45 x 190	200	150	270	✓				✓	✓	✓	✓	✓	✓	✓		8		
Ø50	50 x 125	150	125	210	✓			✓	✓	✓	✓	✓	✓	✓	✓		8		
	50 x 156	200	150	270	✓	✓	✓	✓	✓	✓	✓	✓	✓	✓	✓		8		
	50 x 190	250	200	335	✓			✓	✓	✓	✓	✓	✓	✓	✓		8		
	50 x 205	260	208	368	✓			✓	✓	✓	✓	✓	✓	✓	✓		8		
Ø53	53 x 110	150	120	210	✓	✓	✓	✓	✓	✓	✓	✓	✓	✓	✓		8		
	53 x 139	200	150	270	✓		✓	✓	✓	✓	✓	✓	✓	✓	✓		8		
	53 x 142	200	150	270	✓	✓	✓	✓	✓	✓	✓	✓	✓	✓	✓		8		
	53 x 175	250	200	335	✓	✓	✓	✓	✓	✓	✓	✓	✓	✓	✓		8		
	53 x 205	300	250	410	✓	✓	✓	✓	✓	✓	✓	✓	✓	✓	✓		8		
	53 x 250	359	286	507	✓	✓	✓	✓	✓	✓	✓	✓	✓	✓	✓		8		

DIAMETER	DIMENSION D x L	LIQUID GAS	COMPRESSED GAS	BRIMFUL CAPACITY	SHOULDER SHAPE + OPENING							COLOURS
					FILLING VOLUME							
MM	MM	ML	ML	ML								
Ø59	59 x 120	205	225	275	✓							8
	66 x 130	227	247	297	✓							8
	59 x 140	250	270	320	✓							8
	59 x 180	360	380	430	✓							8
	59 x 215	450	470	520	✓							8
	59 x 225	490	510	560	✓							8
Ø66	66 x 140	323	303	373	✓							8
	66 x 150	357	337	407	✓							8
	66 x 160	390	370	440	✓							8
	66 x 170	424	404	474	✓							8
	66 x 178	451	431	501	✓							8
	66 x 180	458	438	508	✓							8
	66 x 190	591	571	541	✓							8
	66 x 200	525	505	575	✓							8
	66 x 210	599	579	609	✓							8
	66 x 220	592	572	642	✓							8
	66 x 230	626	606	676	✓							8
66 x 240	660	640	710	✓							8	



1" Oval



20mm Crimp Oval



1" Transfer Shoulder



1" Gorge



1" Rim Shoulder  
available on round, oval, fat



1" Flat Shoulder



1" Shaped

ALUMINUM AEROSOL CAN



## AEROSOL VALVE & ACTUATOR



Plain Tinplate Valve



Clear Lacquer Valve



Golden Lacquer Valve



Clear Lacquer Aluminum Valve



Golden Lacquer Aluminum Valve



360 Degree Valve (Tinplate/Alu.)



Spray Paint



Moisturing Valve



Body Spray



Mould Release



Spray Glue



Extinguisher Valve



Epilate Spray



Spray Wax



Powder Valve



Party String Valve

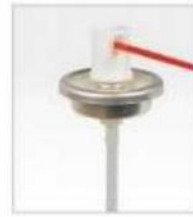

Carburetor  
Contact Valve



Mousse Valve



Multi Purpose  
Foam



Body Deodorant



Hair Spray  
Air Freshener



Snow Spray  
Insecticide Spray



Anti-rust Valve



Air Horn Valve  
Oxygen Valve  
Ink Vale



Blue Spray



Black Spray



Yellow Spray



Light Blue  
Spray



Light Green  
Spray



Yellow Black  
Spray



Red Black  
Spray



Clean Spray



Industry  
White Spray



Industry Gold Spray



Cleaner



Cleaner Blue



Cleaner Yellow











When you are looking for "aluminum packaging", aluminumrock as a leading manufacturers since 2017 is definitely your top choice.

### More than just a anti theft aluminum bottle: a sense of trust

Aluminumrock provides with anti theft aluminum bottles - ideal and reliable packaging solution for packing fragrance, flavours, essential oil, food ingredients, pharmaceutical, veterinary, solvents, agrochemical and sensitive chemicals.

We feature in:

-  Dome shaped aluminium bottles
-  Tamper proof & leak proof closure system
-  Seamless and free from joints
-  Highly durable, non-reactive and non-corrosive
-  Custom logo embossing on bottles/caps
-  Attractive finishes, colors

★★★★★

ISO 9001 Quality Management Standard  
SGS, FDA approve



**PRODUCTION WORK FLOW**

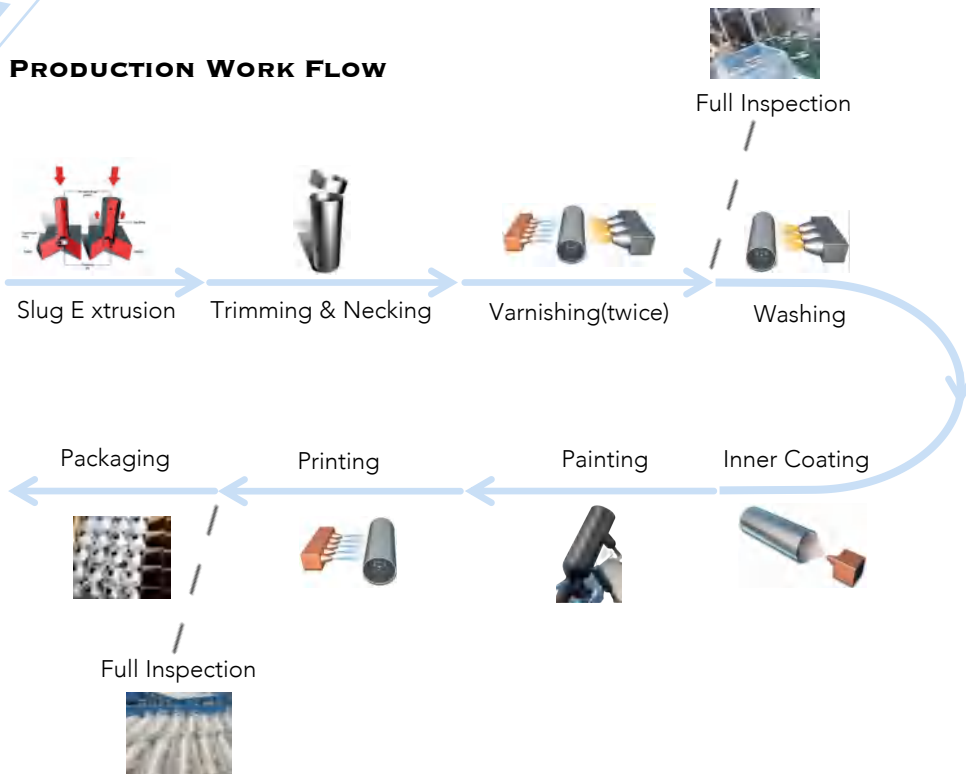



For the round shoulders regular bottle, **30ml to 1.25L** volume is available



### KEY MESSAGES YOU NEED TO KNOW

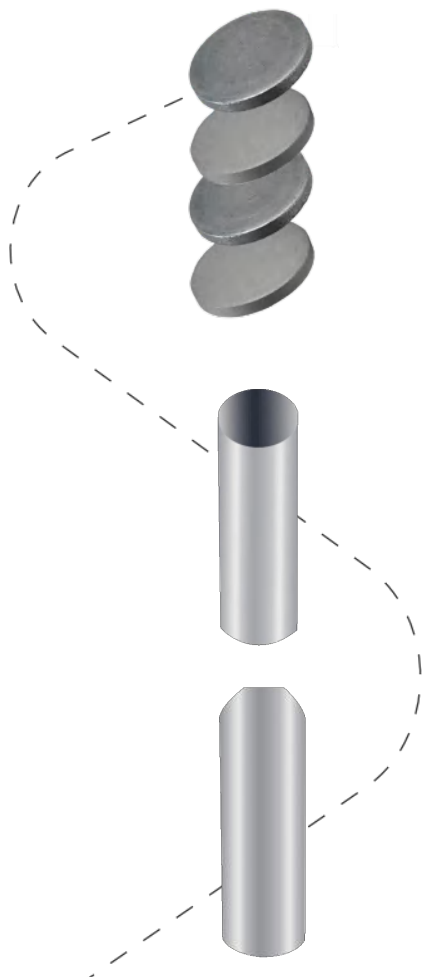

The size of the aluminum slug determines the diameter of the bottle,

and one diameter of the slug can be stretched to different heights, in this stretching process,

while the general factory will adjust the whole straight shape into **round shoulders**.

so the regular round -shouldered bottles are all of the above shapes, with only the difference in capacity.

***If you need shaped bottles such as the overall square shape, the shoulder is flat, square, or anything that is not round can be customized.***

## DIAMETER

PACKAGING  
DETAILS

M M	HEIGHT	TOTAL CAPACITY	PRINTABLE AREA	CASE PACK	CARTON DIMENSION
	M M	ML	M M	PCS/CTN	CM
Ø40	80	50	50	600	
	110	100	80	450	62*36*36
Ø45	65	30	35	450	62*35*35
	70	50	40	500	62*36*36
	76	50	46	590	62*36*36
	145	150	115	400	77*44*49
Ø48	150	200	120	300	49*49*37
Ø50	95	120	65	500	75*39*39
	100	100	70	500	75*49*49
	105	125	75	400	70*49*49
	125	150	95	350	60*49*49
	130	150	100	300	55*45*45
	160	200	120	240	50*45*45
Ø55	120	150	90	250	45*40*30
	130	200	90	230	45*45*37
	150	250	110	200	58*48*31
	170	300	130	200	60*50*30
Ø58	168	350	128	160	65*45*35
Ø59	135	250	95	200	47*47*35
	160	360	120	130	65*57*35
Ø73	176	500	136	100	75*43*42
	196	625	156	80	65*36*42
Ø74	185	500	145	100	75*43*42
Ø88	230	1000	190	80	77*42*49
	245	1250	205	80	77*42*51
	250	1000	210	80	76*40*46
	260	1250	220	70	76*45*54

## CLOSURES

CAP	PLUG
Cap Foam / Aluminum Liner (Tailored Colors Available)	LDPE / Fluorinated



When you are looking for "aluminum packaging", aluminumrock as a leading manufacturers since 2017 is definitely your top choice.

### More than just a aluminum jar: a sense of trust

Aluminumrock provides with a wide selection of aluminum tin containers.

All of our metal containers are food grade and manufactured with rolled edges for safe handling.

Great for tea, candles, and cosmetics, tins are also ideal for spices, candies and other dry products. Order your tin containers wholesale by the case for the best discounts, or less than a case for your smaller projects.

- ✓ Pure aluminum (material AL 99.5)
- ✓ With tamper-evident screw cap made of PP with aluminum/PET inner seal
- ✓ Suitable for food (exception: highly acidic and salt-containing foods)

★★★★★

ISO 9001 Quality Management Standard  
 SGS, FDA approve

**AUTOMATIC PRODUCTION WORK FLOW**

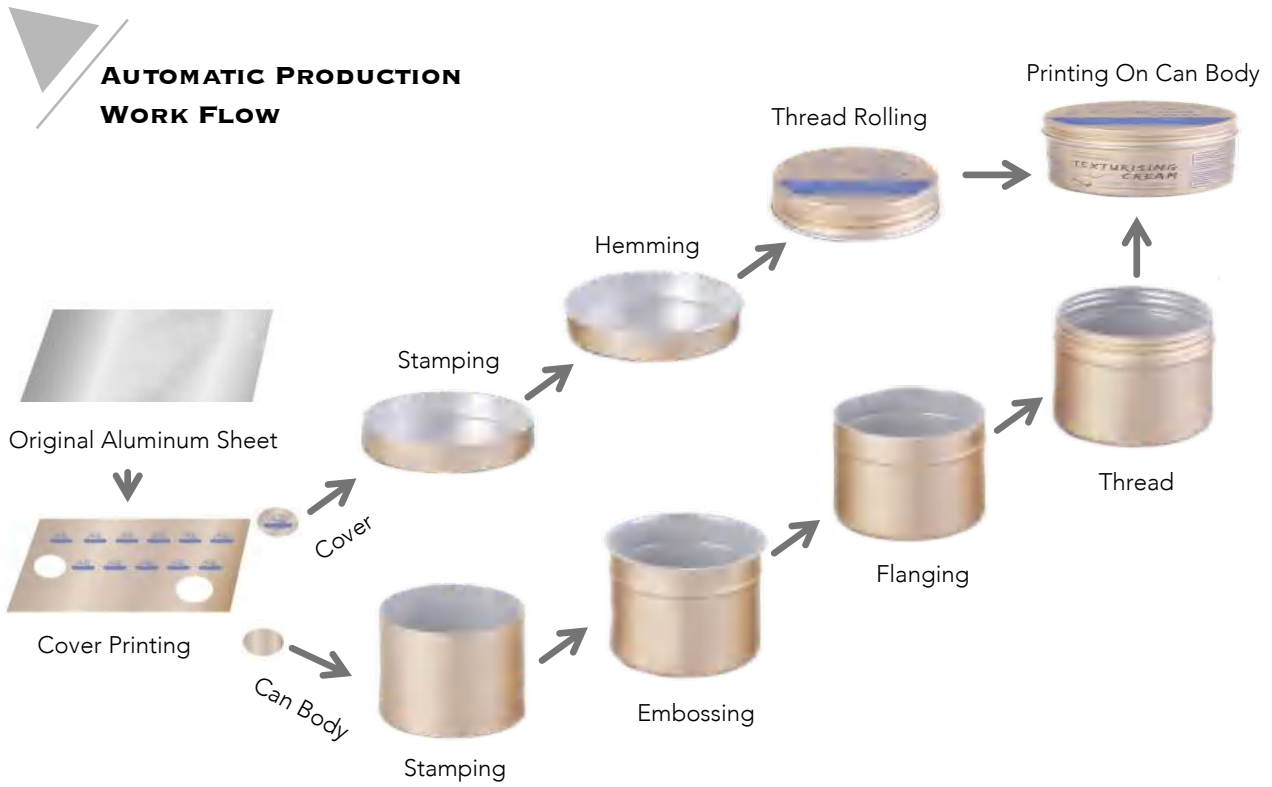

**PRINTING**



**Hollow Punch**

- ✓ MOQ 10kpcs
- ✓ Available in 3 colors
- ✓ Pros: Monochrome effect



**5 Types Of Printing**

Special finishes and unlimited design possibilities.



**Embossing Printing**

- ✓ MOQ 5,000pcs
- ✓ Available in 9 colors
- ✓ Pros: 3 dimensional high-end texture



**Laser Printing**

- ✓ MOQ 100pcs
- ✓ Available in 9 colors
- ✓ Pros: Molding free, very fast production, monochrome effect



**Silk Printing**

- ✓ MOQ 1,000pcs
- ✓ Logo color available in 1-4 colors
- ✓ Pros: 3 dimensional high-end texture



**Label Printing**

- ✓ MOQ 100pcs
- ✓ Available in 9 colors



**Color Printing**

- ✓ MOQ 10kpcs
- ✓ Available in 9 colors



# UNLIMITED ATTRACTIVE ALUMINUM TIN CAN FACTORY

## Multiple Textures



Conventional Aluminum Can Thickness 0.3mm

## Unlimited color



## Multiple Technology



## Multiple Covers

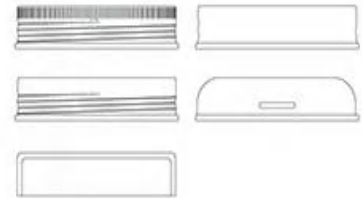

## Multiple Tank Types

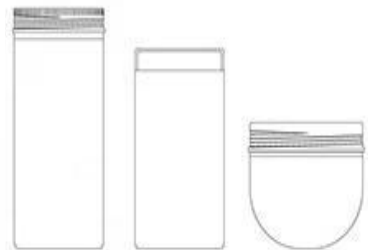
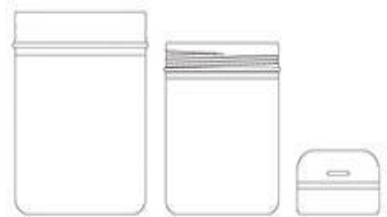

## Multiple Bottoms



ALUMINUM JAR



JAR CAPACITY

1

ALUMINUM SCREW LID JAR

5ml - 1000ml  
0.17oz - 35oz



5ml  
0.17oz



1000ml  
35oz



Tear Off Inner Lid



Non-slip, Feel Good

Aluminum Film Gasket

PE Gasket

Amin Gasket

Bottle Body



2

**ALUMINUM PET/PVC WINDOW JAR**

→ 5ml - 1000ml  
-----  
0.17oz - 35oz

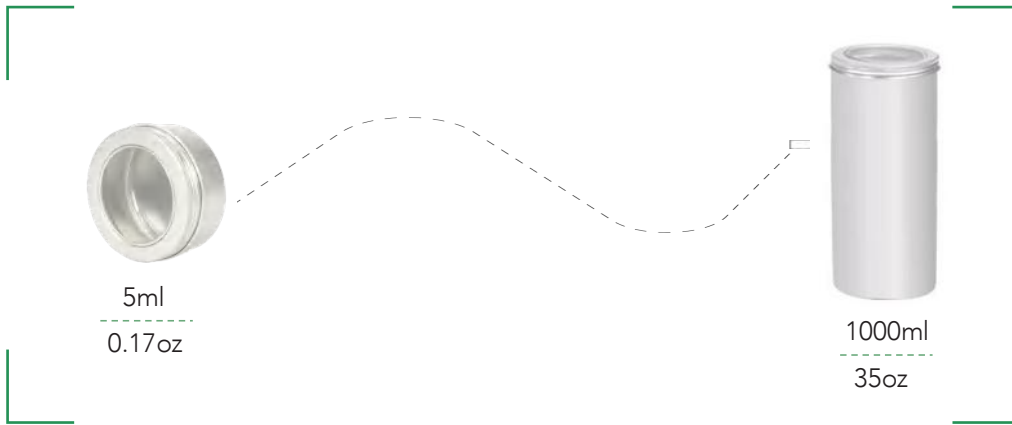

**ALUMINUM CLICK LID JAR**

→ 15ml - 120ml  
-----  
0.5oz - 13oz

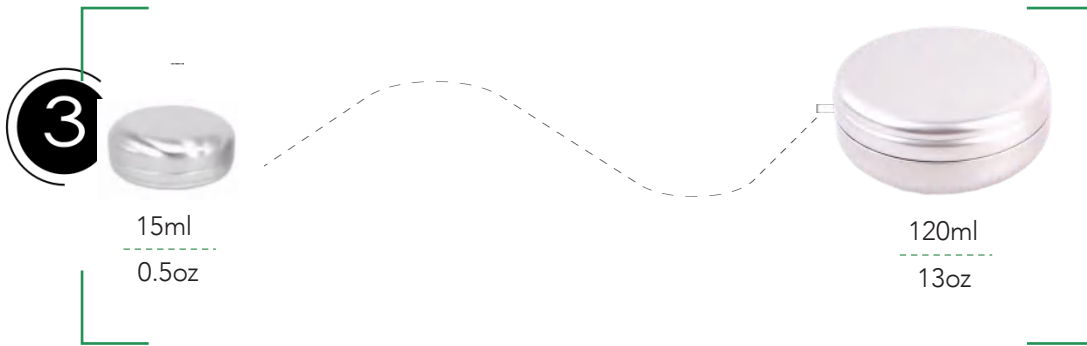

**ALUMINUM RECTANGULAR JAR**

→ 60ml - 150ml  
-----  
2oz - 5oz

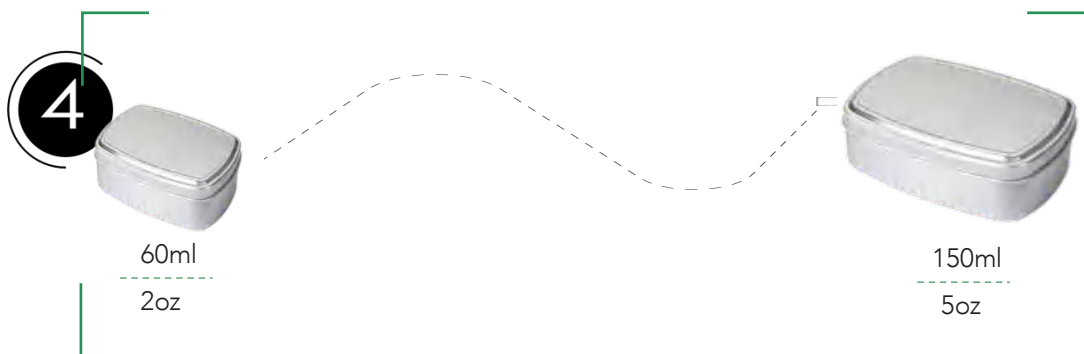

**5**

**ALUMINUM CAPSULE CAN**



50ml - 380ml  
1.7oz - 13.4oz

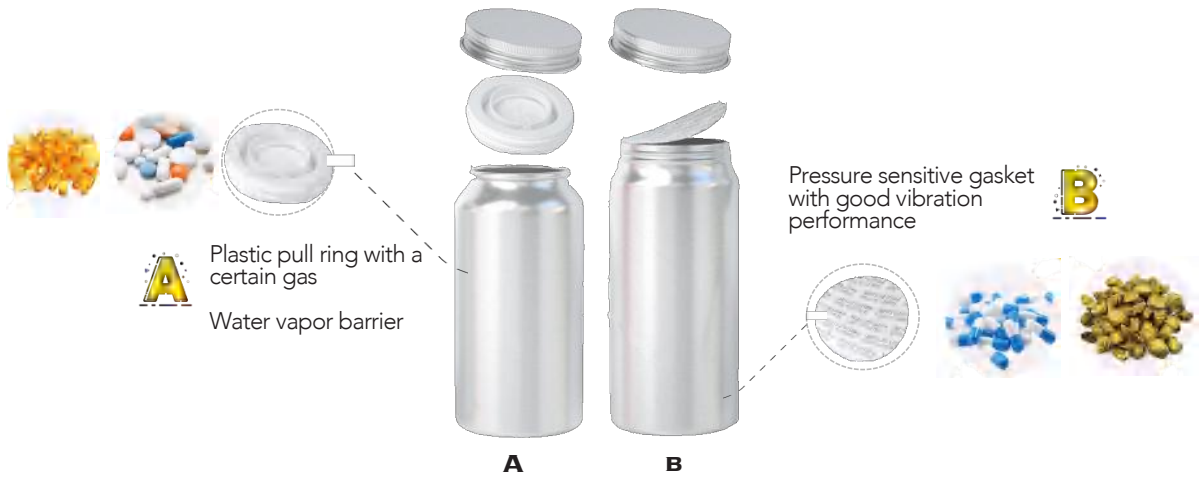
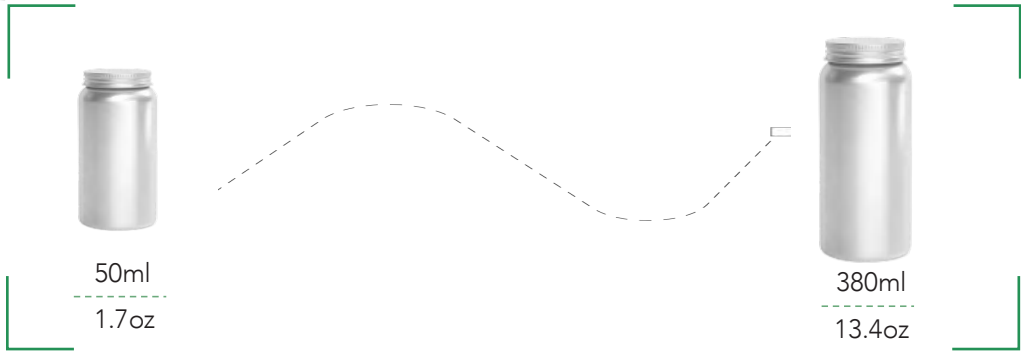

DIAMETER

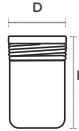

ALUMINUM SCREW LID JAR

M M	HEIGHT	CAPACITY	
	M M	ML	OZ
Ø27	15	5	0.17
	16	8	0.27
Ø35	17	10	0.3
	53	35	1.2
Ø38	24	15	0.5
Ø41	44	45	1.5
Ø45	18	20	0.7
	20	50	1.7
Ø49	18	25	0.8
Ø50	50	70	2.4
Ø52	20	30	1
Ø56	27	55	1.9
Ø65	50	120	4
Ø68	26	60	2
	43	110	3.7
Ø75	24	80	2.7
	29	90	3
	35	100	3.4
Ø77	33	65	2.2
	32	130	4.4
Ø82	34	140	5
	36	150	5
	75	300	10
	95	420	14
	100	500	17
Ø92	115	550	19
	116	750	25
Ø100	30	180	6
	34	200	7
	42	250	8.4
Ø108	36	270	9
	45	350	12
Ø135	55	650	22
	85	1000	34

DIAMETER



ALUMINUM CAPSULE CAN

M M	HEIGHT	CAPACITY	
	M M	ML	OZ
Ø40	60	50	1.7
	90	90	3
Ø45	100	100	3.5
Ø50	100	160	5.6
	110	180	6.3
Ø55	110	220	7.7
	176	380	13.4

DIAMETER



ALUMINUM WINDOW JAR

M M	HEIGHT	CAPACITY	
	M M	ML	OZ
Ø27	15	5	0.2
Ø38	18	15	0.5
Ø45	18	25	0.8
Ø46	27	30	1
Ø50	32	50	1.7
Ø52	64	80	2.7
Ø57	26	60	2
Ø60	47	100	3.4
Ø65	50	120	4
Ø75	60	200	2.8
	70	250	8.4
Ø82	75	300	10
	81	350	12
	100	500	17
	115	650	22
	195	1000	34

DIAMETER



M M	HEIGHT	CAPACITY	
	M M	ML	OZ
Ø40	20	15	0.5
Ø50	24	30	1
Ø66	33	60	2
Ø75	15	50	1.7
	35	100	3.4
Ø78	33	90	3
Ø80	28	120	4

HEIGHT



M M	LENGTH X WIDTH	CAPACITY	
	M M	ML	OZ
22	61x45	60	2
24	72x53	80	2.8
	94x60(hinged lid)	125	4.2
25	90x62(push pull lid)	120	4
26	70x70	90	3
27	83x62	100	3.4
28	96x70	150	5



**CUSTOMIZED MOLDING SIZE IS AVAILABLE**



**CLICK TO [GET QUOTATION NOW](#)**

When you are looking for "aluminum packaging", aluminumrock as a leading manufacturers since 2017 is definitely your top choice.



### More than just a aluminum collapsible tube: a sense of trust

To best meet your requirements, we are able to propose a large range of caps and accessories.

Thanks to our experience and innovation we can offer many different types of finish, from a simple, natural « bare » finish to more complex finishes (gloss, coloured, pearl, matt... ).

- ✓ Pure aluminum (material AL 99.7)
- ✓ Unlimited colors



ISO 9001 Quality Management Standard  
SGS, FDA approve



## AUTOMATIC PRODUCTION WORK FLOW

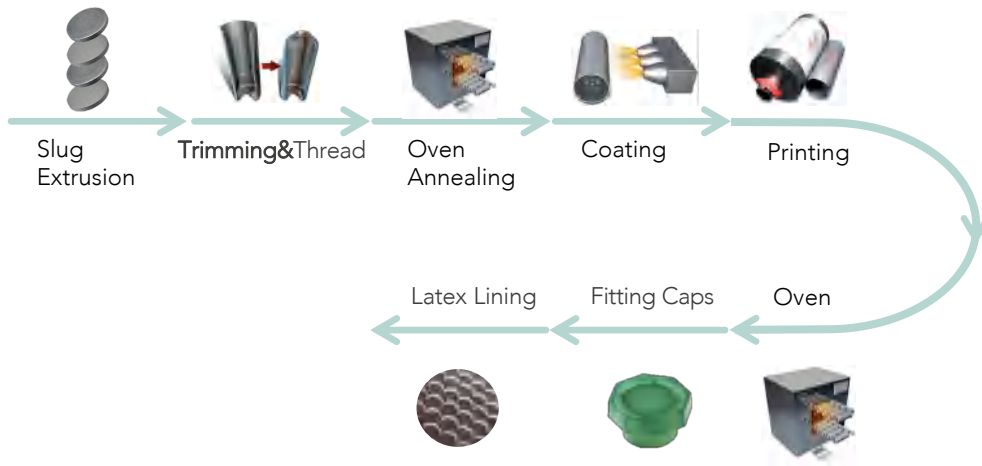

## ADVANTAGES



### Available Caps

- + Mushroom Caps
- + Ribbed Needle Nose caps
- + Pierced Through Caps
- + Octagonal Caps
- + Wood Grains Caps
- + Flip Top Caps
- + Disc Top Caps



### Diameter

Ø13.5mm, Ø16mm, Ø19mm, Ø22mm, Ø25mm, Ø28mm, Ø30mm, Ø35mm, Ø38mm, Ø40mm



### Available Volume

10ml to 200ml

### Printing ≡ Colors

Offset printing  
Screen printing  
Labeling





# AUTOMATIC ALUMINUM TUBE PRODUCTION LINES

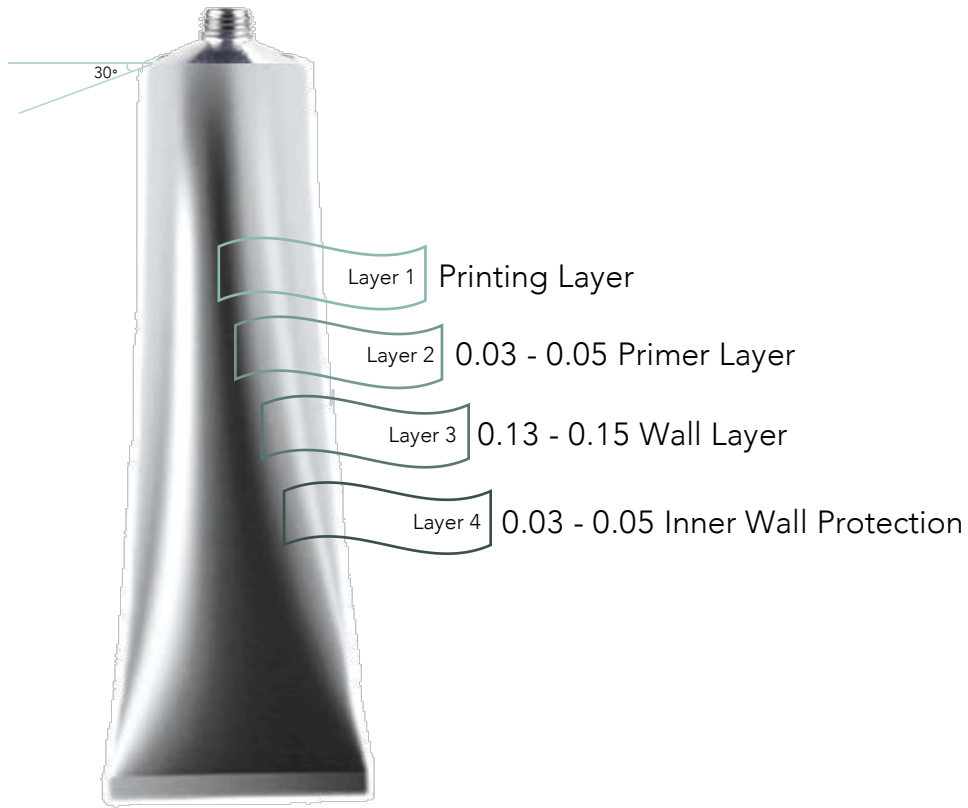

Inner Coating: Imported from Switzerland, speci for hair dye paste, coating

Alkali resistance up to a PH = 12



Tail Glue: High specification tail glue, with excellent viscosity

Sealing good features to protect the safety of the content

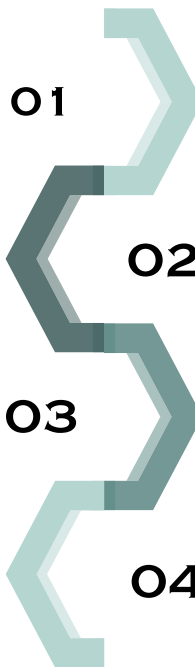

Aluminum: 99.7% aluminum



Base And Ink: The best quality coating, the main material for polyester, with high temperature non-stick

Low temperature non-stripping

Good toughness and other characteristics.



**NOZZLES**

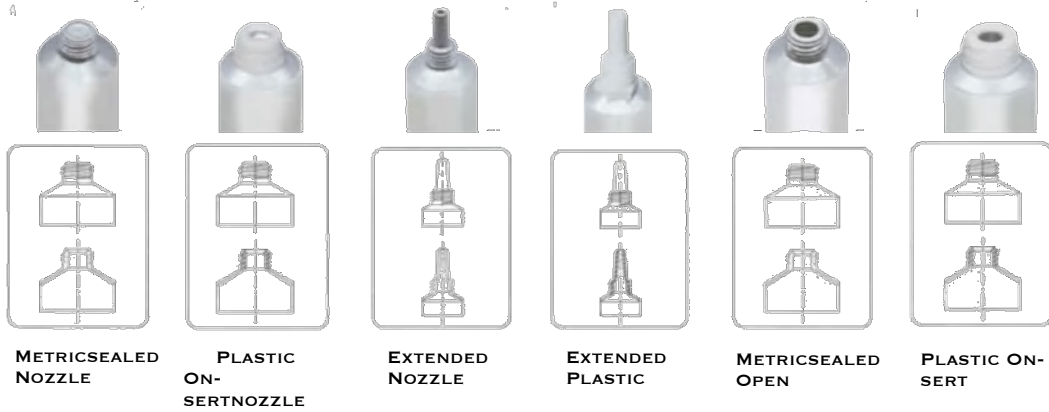

**SHAPES**

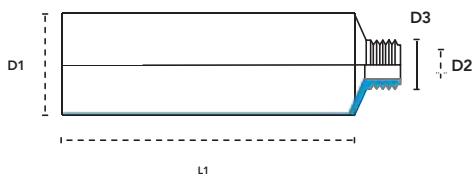

**Cylindrical aluminium tubes**

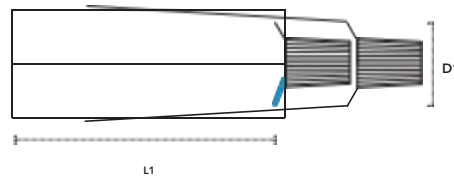

**Conical tubes**

For all diameters between 13.5 and 35.0 we offer standard conical angles on request max. length 200 mm.

THREADS AND ORIFICES D3/D2	D1 mm											
	11	12	13.5	16	19	22	25	28	30	32	35	40
M7/3.5	√	√	√									
M9/5.5		√	√	√	√	√	√	√	√			
M11/7				√	√	√	√	√	√	√	√	√*
M13/7						√**	√**	√**	√**	√**	√**	
M15/10								√	√	√	√	√
M20/15											√*	√*

\*only round open    \*\*only with plastic nozzle / ring

BODY LENGTH	D1 mm											
	11	12	13.5	16	19	22	25	28	30	32	35	40
Min.	47	48	50	65	75	95	90	100	100	110	110	105
Max.	77	90	110	120	145	160	185	180	200	185	210	230



DIAMETER

		DIAMETER														
LENGTH	Ø11	Ø12	Ø13.5	Ø14	Ø16	Ø19	Ø20	Ø22	Ø25	Ø27	Ø28	Ø30	Ø32	Ø35	Ø38	Ø40
3	50															
4	70	60	45	43												
5		70	55	53												
6			70	68												
7			80	78	65											
8			90	85	70											
10			95	90	75											
12				105	90											
16					110	90										
20						105	100	90								
25						120	110	105								
30						140	130	115								
35							140	130	110							
40								150	120							
50									160	135	130					
60										155	150	135				
70										170	165	155	130			
80										185	180	170	150			
90												180	170			
100												190	180	160	150	
110													190	170	165	
115														175	170	
125														185	180	
135														195	190	135
145															200	140
155																146
165																153
175																160
185																166
195																173
200																175

ALUMINUM COLLAPSIBLE TUBE



### ALUMINUM SCREW LID JAR

#### LATEX

Distribute evenly without falling off

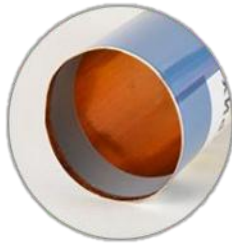

#### PRINTING

Available in 6 colors

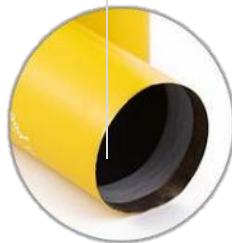

#### INNER COATING

PPG, good adhesion and uniformity

#### SCREW

No buildup, perfect fit to the lid





**ALUMINUM SCREW LID JAR**



Spike Cap(S)



Spike Cap(M)



Spike Cap(L)



Conical Cap



Octagonal Cap(S)



Octagonal Cap(M)



Octagonal Cap(L)



Doctor Flip Cap



25mm Standup Cap



30mm Standup Cap



35mm Standup Cap



38mm Standup Cap



**ZHEJIANG YESTRONG SUPPLY CO.,LTD**

#505, Building 12, #135 Liuhe Rd, Xihu District, Hangzhou,  
Zhejiang, 310023, China



[www.aluminumrock.com](http://www.aluminumrock.com)



[inquiry@aluminumrock.com](mailto:inquiry@aluminumrock.com)